

MINIATURE RELAY

2 POLES—1 to 2 A (FOR SIGNAL SWITCHING)

BA SERIES

■ FEATURES

- Slim type relay for high density mounting
- CSA recognized
- Conforms to IEC60950, Bellcore specification and FCC Part 68
 - Clearance more than 2.0 mm between coil and contacts
 - Creepage more than 2.5 mm between coil and contacts
 - Dielectric strength 2,000 VAC between coil and contacts
 - Surge strength 3,000 V between coil and contacts (at 2 × 10 μs surge wave)
- High sensitivity and low consumption power
- Latching type available
- High reliability—bifurcated contacts
- Plastic sealed type
- Conforms to UL (under approval)
- SMT is available: BAS

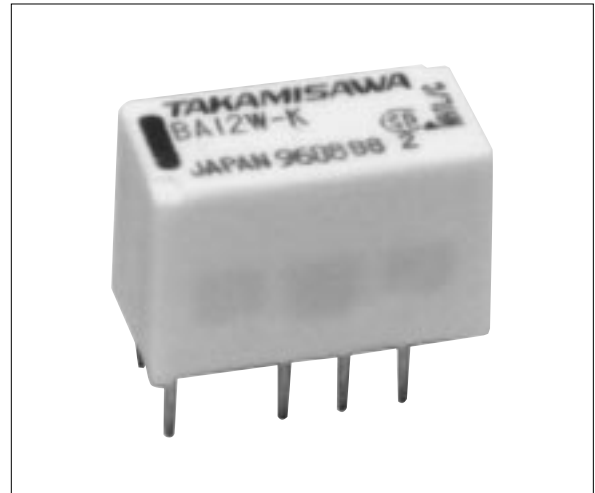

■ ORDERING INFORMATION

[Example] BA L - D 12 W K
 (a) (b) (*) (c) (d) (e) (g)

(a)	Series Name	BA : BA Series
(b)	Operation Function	Nil : Standard type L : Latching type
(c)	Number of Coil	Nil : Single winding type D : Double winding type
(d)	Nominal Voltage	Refer to the COIL DATA CHART
(e)	Contact	W : Bifurcated type
(g)	Enclosure	K : Plastic sealed type

Note: Actual marking omits the hyphen (-) of (*)

■ SAFETY STANDARD AND FILE NUMBERS

CSA CERTIFIED NRTL/C to C22.2 No. 14 No. 950 (File No. LR35579), UL 508, 1950 (File No. E45026)

Relay type	Nominal voltage	Contact rating	
BA BAL BALD	1.5 to 48 VDC	0.5 A 125 VAC 2 A 30 VDC 0.3 A 110 VDC	resistive

■ SPECIFICATIONS

Item		Standard	Single Winding Latching Type	Double Winding Latching
		BA-() W-K	BAL-() W-K	BAL-D () W-K
Contact	Arrangement	2 form C (DPDT)		
	Material	Gold overlay silver alloy		
	Style	Bifurcated		
	Resistance (initial) (at 1 A 6 VDC)	Maximum 50 mΩ		
	Rating (resistive)	0.5 A 125 VAC or 1 A 30 VDC		
	Maximum Carrying Current	2 A		
	Maximum Switching Power	62.5 AV, 30 W		
	Maximum Switching Voltage	250 VAC, 220 VDC		
	Maximum Switching Current	2 A		
	Minimum Switching Load*1	0.01 mA 10 mVDC		
	Capacitance	Approximately 0.5 pF (between open contacts, adjacent contacts) Approximately 1.0 pF (between coil and contacts)		
Coil	Nominal Power (at 20°C)	0.25 to 0.36 W	0.2 W	0.36 W
	Operate Power (at 20°C)	0.14 to 0.2 W	0.15 W	0.205 W
	Operating Temperature	-40°C to +70°C (no frost) (refer to the CHARACTERISTIC DATA)		
Time Value	Operate (at nominal voltage)	Maximum 6 ms	Maximum 6 ms (set)	
	Release (at nominal voltage)	Maximum 4 ms	Maximum 6 ms (reset)	
Insulation	Resistance (at 500 VDC)	Minimum 1,000 MΩ		
	Dielectric Strength	between open contacts	1,000 VAC 1 minute	
		between adjacent contacts		
		between coil and contacts	2,000 VAC 1 minute	1,000 VAC 1 minute
Surge Strength	3,000 V (at 2 × 10 μs)		1,500 V (at 10 × 160 μs)	
Life	Mechanical	1 × 10 ⁷ operations minimum		
	Electrical	2 × 10 ⁵ operations minimum (0.5 A 125 VAC) 5 × 10 ⁵ operations minimum (1 A 30 VDC)		
Other	Vibration Resistance	Misoperation	10 to 55 Hz (double amplitude of 3.3 mm)	
		Endurance	10 to 55 Hz (double amplitude of 5.0 mm)	
	Shock Resistance	Misoperation	500 m/s ² (11 ±1 ms)	
		Endurance	1,000 m/s ² (6 ±1 ms)	
	Weight	Approximately 1.9 g		

*1 Minimum switching loads mentioned above are reference values. Please perform the confirmation test with the actual load before production since reference values may vary according to switching frequencies, environmental conditions and expected reliability levels.

BA SERIES

■ COIL DATA CHART

MODEL		Nominal voltage	Coil resistance (±10%)	Must operate voltage*1	Must release voltage*1	Nominal power
Standard Type	BA-1.5 W-K	1.5 VDC	9 Ω	+1.13 VDC	+0.15 VDC	250 mW
	BA- 3 W-K	3 VDC	36 Ω	+2.25 VDC	+0.3 VDC	250 mW
	BA-4.5 W-K	4.5 VDC	81 Ω	+3.38 VDC	+0.45 VDC	250 mW
	BA- 5 W-K	5 VDC	100 Ω	+3.75 VDC	+0.5 VDC	250 mW
	BA- 6 W-K	6 VDC	144 Ω	+4.5 VDC	+0.6 VDC	250 mW
	BA- 9 W-K	9 VDC	324 Ω	+6.75 VDC	+0.9 VDC	250 mW
	BA- 12 W-K	12 VDC	576 Ω	+9.0 VDC	+1.2 VDC	250 mW
	BA- 18 W-K	18 VDC	1,296 Ω	+13.5 VDC	+1.8 VDC	250 mW
	BA- 24 W-K	24 VDC	2,304 Ω	+18.0 VDC	+2.4 VDC	250 mW
	BA- 48 W-K	48 VDC	6,400 Ω	+36.0 VDC	+4.8 VDC	360 mW

Note: *1 Specified values are subject to pulse wave voltage.
All values in the table are measured at 20°C.

MODEL		Nominal voltage	Coil resistance (±10%)	Set voltage*1	Reset voltage*1	Nominal power
Single Winding Latching Type	BAL-1.5 W-K	1.5 VDC	11.25 Ω	+1.13 VDC	-1.13 VDC	200 mW
	BAL- 3 W-K	3 VDC	45 Ω	+2.25 VDC	-2.25 VDC	200 mW
	BAL-4.5 W-K	4.5 VDC	101 Ω	+3.38 VDC	-3.38 VDC	200 mW
	BAL- 5 W-K	5 VDC	125 Ω	+3.75 VDC	-3.75 VDC	200 mW
	BAL- 6 W-K	6 VDC	180 Ω	+4.5 VDC	-4.5 VDC	200 mW
	BAL- 9 W-K	9 VDC	405 Ω	+6.75 VDC	-6.75 VDC	200 mW
	BAL- 12 W-K	12 VDC	720 Ω	+9.0 VDC	-9.0 VDC	200 mW
	BAL- 18 W-K	18 VDC	1,620 Ω	+13.5 VDC	-13.5 VDC	200 mW
	BAL- 24 W-K	24 VDC	2,880 Ω	+18.0 VDC	-18.0 VDC	200 mW
Double Winding Latching Type	BAL-D1.5 W-K	1.5 VDC	P 6.25 Ω	+1.13 VDC	+1.13 VDC	360 mW
			S 6.25 Ω			
	BAL-D 3 W-K	3 VDC	P 25 Ω	+2.25 VDC	+2.25 VDC	360 mW
			S 25 Ω			
	BAL-D4.5 W-K	4.5 VDC	P 56.3 Ω	+3.38 VDC	+3.38 VDC	360 mW
			S 56.3 Ω			
	BAL-D 5 W-K	5 VDC	P 69.4 Ω	+3.75 VDC	+3.75 VDC	360 mW
			S 69.4 Ω			
	BAL-D 6 W-K	6 VDC	P 100 Ω	+4.5 VDC	+4.5 VDC	360 mW
			S 100 Ω			
	BAL-D 9 W-K	9 VDC	P 225 Ω	+6.75 VDC	+6.75 VDC	360 mW
			S 225 Ω			
BAL-D 12 W-K	12 VDC	P 400 Ω	+9.0 VDC	+9.0 VDC	360 mW	
		S 400 Ω				
BAL-D 18 W-K	18 VDC	P 900 Ω	+13.5 VDC	+13.5 VDC	360 mW	
		S 900 Ω				
BAL-D 24 W-K	24 VDC	P 1,600 Ω	+18.0 VDC	+18.0 VDC	360 mW	
		S 1,600 Ω				

Note: *1 Specified values are subject to pulse wave voltage.
All values in the table are measured at 20°C.

P: Primary coil S: Secondary coil

CHARACTERISTIC DATA

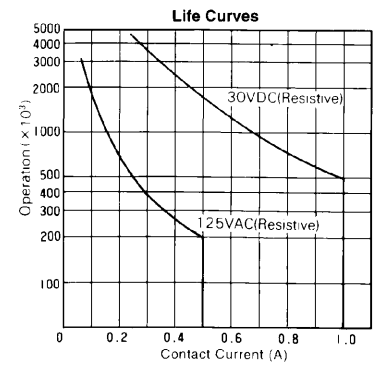
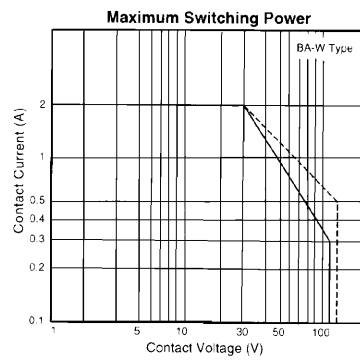
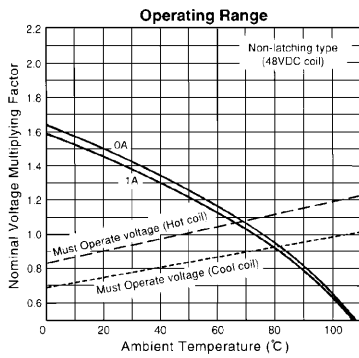
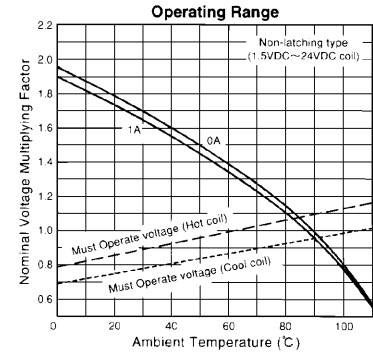
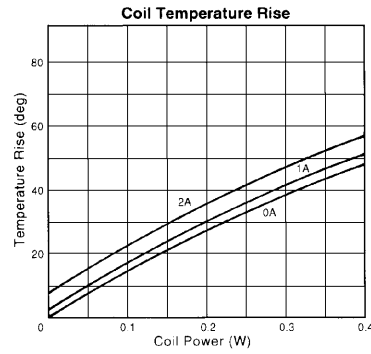
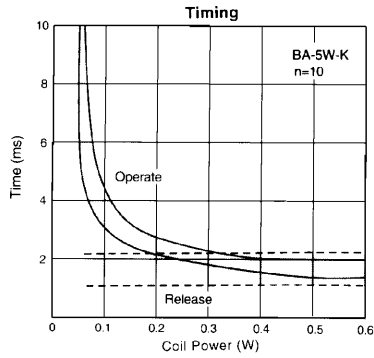

REFERENCE DATA

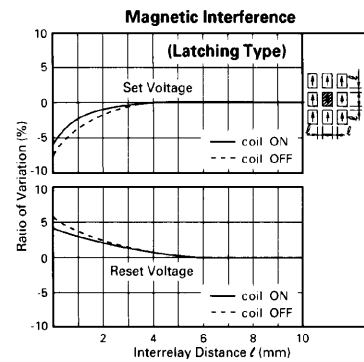
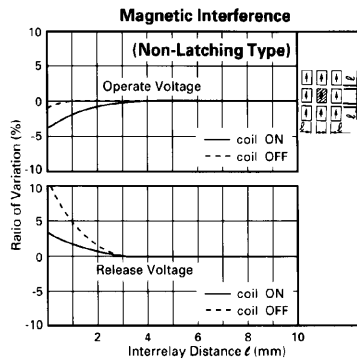
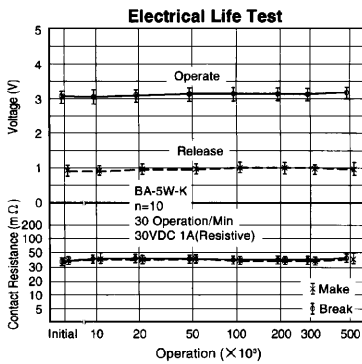
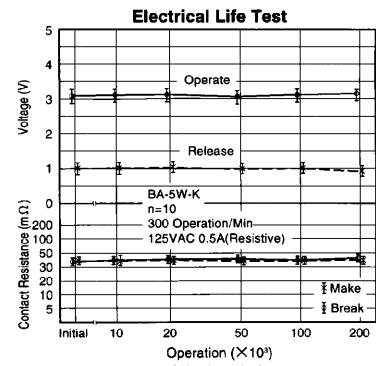
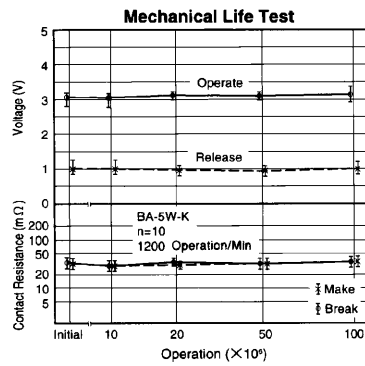
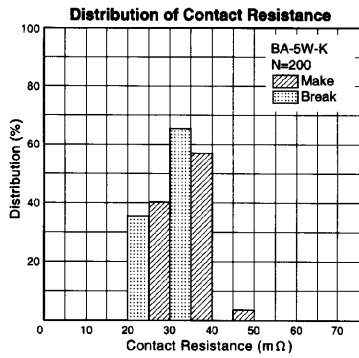
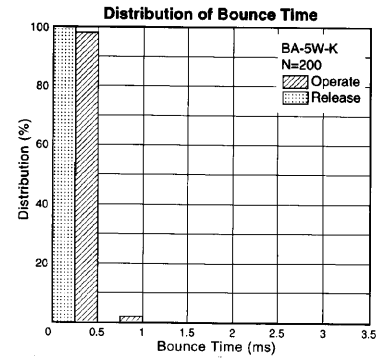
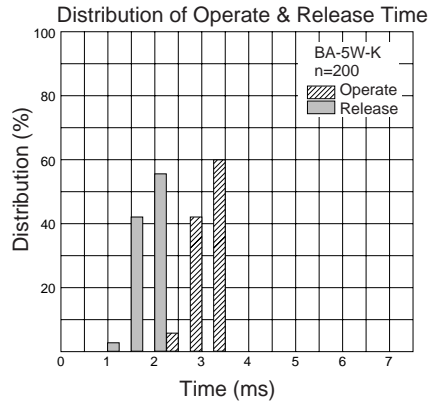
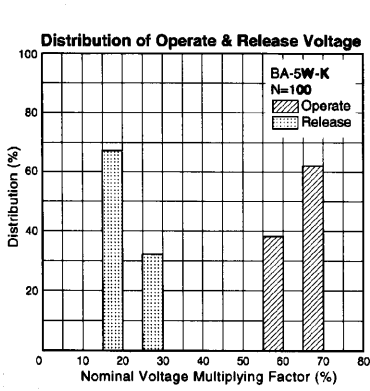

■ DIMENSIONS

● Dimensions

BA, BAL, BA-WD type (Non-latching, single winding latching, MBB type)

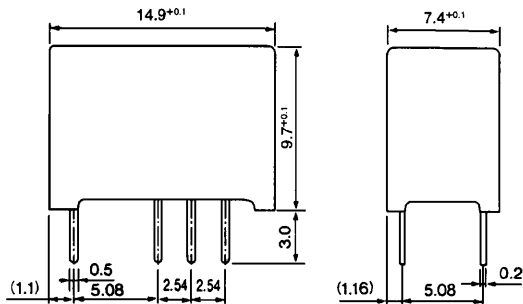

● Schematics

(Bottom View)

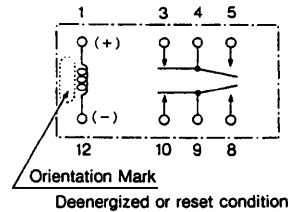

● PC board mounting

hole layout

(Bottom view)

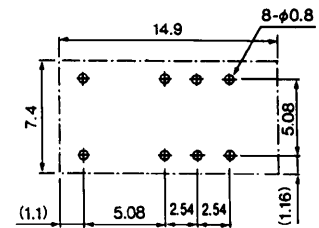

BAL-D type (Double winding latching type)

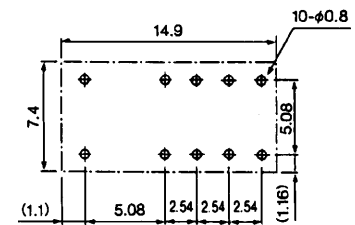
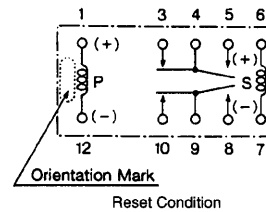
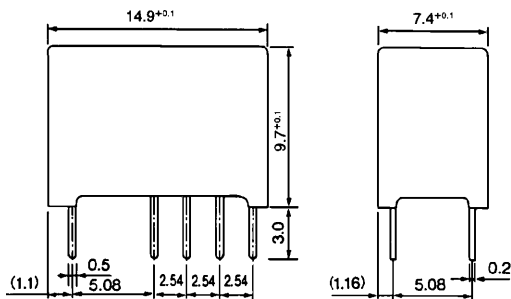

Unit: mm

Fujitsu Components International Headquarter Offices

Japan

Fujitsu Component Limited
Gotanda-Chuo Building
3-5, Higashigotanda 2-chome, Shinagawa-ku
Tokyo 141, Japan
Tel: (81-3) 5449-7010
Fax: (81-3) 5449-2626
Email: promothq@ft.ed.fujitsu.com
Web: www.fcl.fujitsu.com

North and South America

Fujitsu Components America, Inc.
250 E. Caribbean Drive
Sunnyvale, CA 94089 U.S.A.
Tel: (1-408) 745-4900
Fax: (1-408) 745-4970
Email: marcom@fcai.fujitsu.com
Web: www.fcai.fujitsu.com

Europe

Fujitsu Components Europe B.V.
Diamantlaan 25
2132 WV Hoofddorp
Netherlands
Tel: (31-23) 5560910
Fax: (31-23) 5560950
Email: info@fceu.fujitsu.com
Web: www.fceu.fujitsu.com

Asia Pacific

Fujitsu Components Asia Ltd.
102E Pasir Panjang Road
#04-01 Citilink Warehouse Complex
Singapore 118529
Tel: (65) 375-8560
Fax: (65) 273-3021
Email: fcal@fcal.fujitsu.com
www.fcal.fujitsu.com